

## How to assemble your CT200D

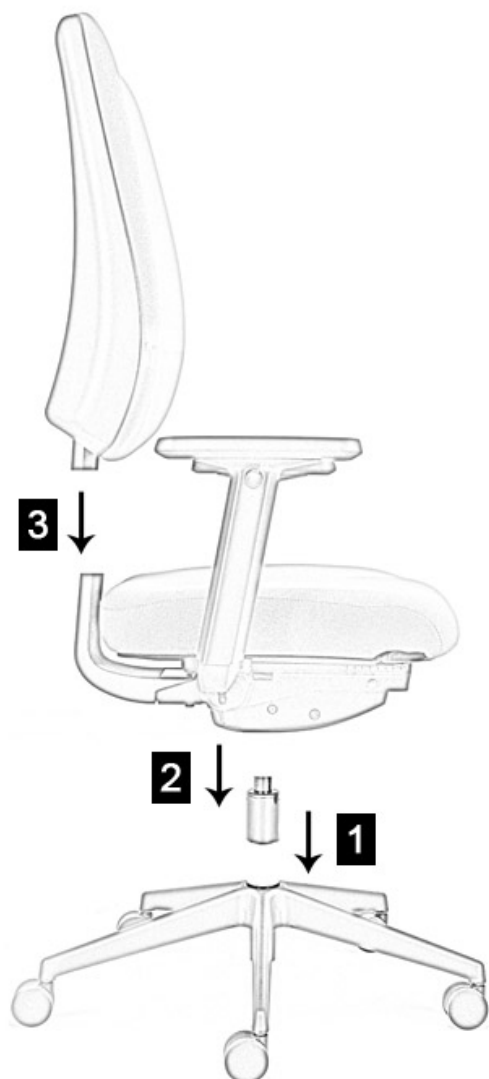

### Key Information



2 Person Assembly Recommended.



Push Fit Assembly - No Bolts Required.



No Tools Required To Build This Product.



This product can be assembled within 10 minutes.



This product is rated as EASY to assemble.



Check Chair Structure Every 3 Months for Max Stability.



Please note that this product will be heavy when assembled. Please ensure that if you need to lift or carry this product that you do not do this by yourself.

### 1 Locate the Gas Lift

Remove the 5 star base from the box and place it down on the floor. Remove the gas lift from the box and firmly push it into the hole located in the centre of the 5 star base. Please ensure that the gas lift is located securely before continuing to step 2.

### 2 Locate the Seat Pan

Remove the pre-assembled seat and mechanism from the box and locate onto the gas lift by fitting the top of the gas lift into the circular hole of the seat mechanism. Press down firmly to ensure the seat is fitted securely before moving on to step 3.

### 3 Locate the Chair Back

Remove pre-assembled chair back from the box and push it firmly into the aperture at the rear of the seat assembly. Your product is now assembled. Please make sure that all push fit connections are secure before using your product.